

1T6703DA | FORTYEIGHT Label 2

Low voltage adjustable LED professional projector

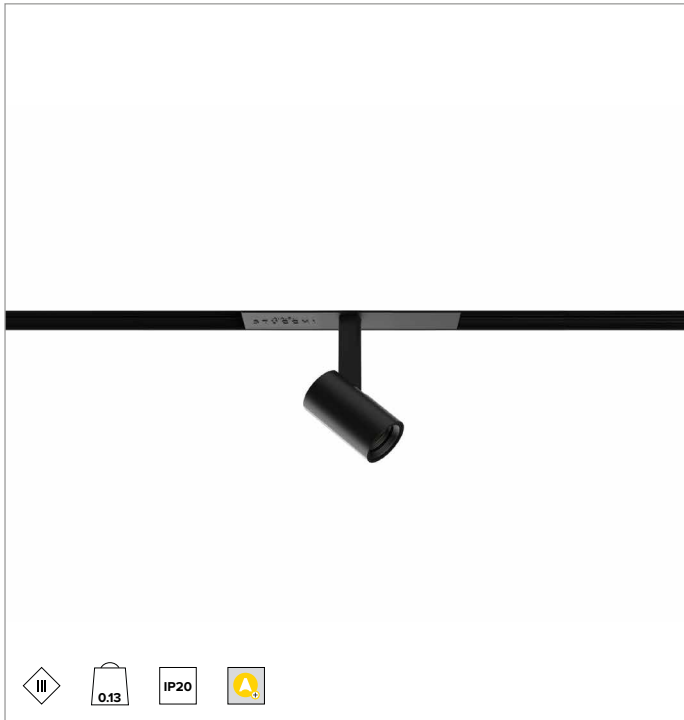

	3000K	H(m)	D(m)	Emax(lx)		
	Ra90		31°			
Fixture Power	4W	1	0.55	346		
Source Flux	180lm	2	1.10	87		
Fixture Flux	136lm	3	1.65	38		
Efficacy	36lm/W	4	2.19	22		
TS1158	Imax=1920cd/klm	Imax	346cd	5	2.74	14

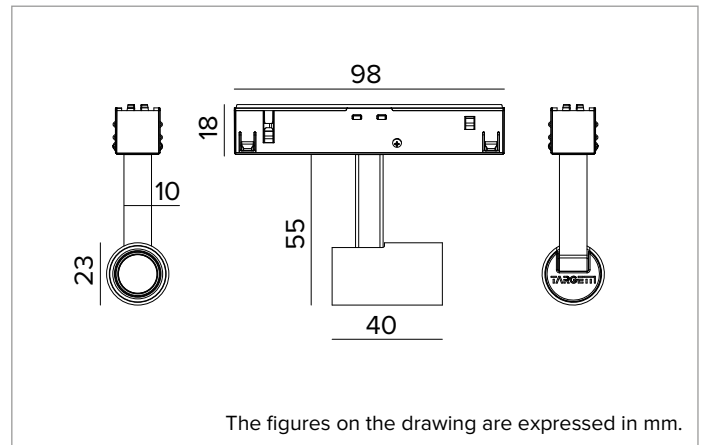

SOURCE

High efficiency Ra90 LED Emitter. 3500K on request.

Energy efficiency class: G

Nominal power: 2,6W

Nominal flux: 180lm

Colour rendering index: 90

Rf: 89.3

Rg: 104.3

CCT nominal: 3000K

SDCM: 1.5

Lifetime (L80/B10): >50000h tq +25°C

ILLUMINOTECHNICAL CHARACTERISTICS

FL- transparent PMMA lens and holographic filter with different openings depending on the version with a black silicone cut off ring.

Optic: LENS

Beam angles: FL

Optical efficiency: 76%

Fixture flux: 136lm

Luminous efficacy: 36lm/W

Photobiological safety: Compliant with RG1 low risk group

MECHANICAL CHARACTERISTICS

Painted aluminium body. Optical frame adjustable from 0° to 90° on the vertical plane, 360° on the horizontal plane.

Colour and finish: Deep black

Dimensions: D=23mm

Weight: 0.13Kg

Version: LONG ARM DALI

Degree of protection: IP20

ELECTRICAL CHARACTERISTICS

DALI version with track power supply. Casambi control system available using a dedicated accessory.

Fixture Power: 4W

Power supply: 48Vdc

Insulation Class: CLASS 3

Class F: YES

Ambient temperature: 0°C / +25°C

INSTALLATION

Long bracket version for insertion into the trimless deep track version. Quick coupling system for mounting the product on the track.

NOTES

Not polarized fixture. The arm is and the adapter are supplied in the same colour as the body of the projector. 110-277Vac version available on request. Commissioning of the control system via free APP; the intervention of a specialist technician can be quoted on request.

WARRANTY

5 years.

WARNING

Luminaire designed for disposal/recycling at end-of-life. Replaceable (LED only) light source by a professional. Replaceable control gear by a professional.

Due to the technological evolution of the electronic components, the data provided may be updated, and as such, confirmation must be requested during the order process.

Luminous flux and power supply have +/-10% tolerances with respect to the indicated value. tq +25°C (CIE 121).

We reserve the right to make technical changes.

Targetti Sankey S.r.l.
Via Pratese, 164
50145 Firenze - Italy
Tel: +39 055 37911
targetti.com
targetti@targetti.com

CCIAA Firenze
Share Capital:
€ 500.000,00
VAT N. (IT):
01537660480
R.E.A: FI-275656

TARGETTI

1T6703DA | FORTYEIGHT Label 2

Low voltage adjustable LED professional projector

Accessories

Filter



Ø mm	Code
17	1T6939

Holographic PMMA filter with blade of light effect.
Allows the beam to be made oval; combined with spot and flood optics the effect appears more pronounced.

Due to the technological evolution of the electronic components, the data provided may be updated, and as such, confirmation must be requested during the order process.

Luminous flux and power supply have +/-10% tolerances with respect to the indicated value. tq +25°C (CIE 121).

We reserve the right to make technical changes.

Targetti Sankey S.r.l.
Via Pratese, 164
50145 Firenze - Italy
Tel: +39 055 37911
targetti.com
targetti@targetti.com

CCIAA Firenze
Share Capital:
€ 500.000,00
VAT N. (IT):
01537660480
R.E.A: FI-275656

TARGETTI